

MY LAST LAST BOAT (I think)

I was born in 1935. Since 1959 I have always had a boat or two - about 20 total - from an 8ft racing boat with 10hp outboard to a 32ft houseboat. Many were homemade, many were older boats I fixed - and I purchased six boats new (including five inflatables). These notes cover my experiences with my five inflatable boats, with details on my *last*, last boat. Royal Dossett rjdossett@gmail.com

1994. **12ft Sea Eagle with used Mercury 10hp outboard.** I carried the boat and motor on a roller rack with 12v winch on top of a full-size van. Boat eventually wore out.



1998. **12ft Sea Eagle with the used 10hp outboard and remote controls.** I rigged an ancient shift/throttle control box and Telex steering to the tiller motor (still pull-start and manual tilt). I built a trailer based on a Northern Tool Folding Trailer. I also made a lift (not shown) to park the boat in the water near a dock. I eventually sold boat/motor/trailer, and dismantled the lift.



2002. **15ft Saturn with new Honda 20hp motor and full remote control.** I made a trailer based on a Northern Tool 5x8ft trailer. The width nicely matched the boat tube spacing of 60". Flat bunks and a swing tongue facilitated floating the boat onto the bunks in deep water, with a bow line (no winch). This was my favorite inflatable. I sold the boat/motor/trailer. My last inflatable, or so I thought!



2020. **12ft Mars with new Tohatsu 6hp outboard.** I built a roller rack for the top of my Toyota RAV4, with remote control (blue tooth) 12v winch. The boat motor had to be removed to pull the boat onto the rack. It was time consuming to install/remove the roller rack and remove/add the motor so I built a trailer for the roller rack. The trailer was a Northern Tool Utility trailer. I added a long tongue and installed the roller rack removed from the SUV on the trailer, and added a manual winch. I eventually sold boat/motor/trailer.



2022. **16ft Saturn with new Honda 20hp motor and full remote control.** This is similar to the 15ft boat but only a 16ft was available (shortage during Covid pandemic). This boat has roller bunks. Detail notes following this page cover the boat and trailer, showing innovations learned from past experiences. This is my *last last* boat. (??)



16ft INFLATABLE - PROS and CONS

Boat and Trailer

- fits in garage or 10x20ft storage
- easy to tow with any vehicle
- boat cover against rain, snow, etc
- travel up to 70mph with cover
- easy to maneuver by hand on land
- no dock needed at ramp
- beach boat; step in/out from ramp
- simple launch/retrieve from ramp

Boat

- planes with 20hp motor
 - extremely maneuverable
 - very shallow draft
 - very stable
 - safe in terrible water conditions
 - add/arrange/rearrange seats
 - close to water surface
- CONS - rough riding in rough water

IDEAS

Here are many things used on the 16ft boat.

TRAILER

Tongue - 3x3" steel pipe added

Lights extension - 20ft extension cord routed through tongue

Fender braces - added to keep fenders from bouncing

Bunk rails - 16ft 2x4 treated wood (4)

Tail lights - placed to meet regulations

Rollers - EMT axles, PVC pipe rollers

Front stop guides - 2x2 wood posts, PVC pipes

Side guides - EMT or 2x2 wood posts, PVC pipes

Rear bumper - 2x2 wood bumpers, PVC pipes

Winch mount - 5/4 deck board

Winch cable guides - 1/2" carriage bolts, EMT rollers

12v system - SAE two-conductor "solar" cables & connectors

BOAT

Bow line - 50ft rope attached to the bow ring

Winch harness - chain hooked to boat tow handles

Floor - aluminum floor > 3/4" foam board > 3/4" treated plywood

Seats - lag-bolted to 3/4" plywood bilge floor

Aft Bench - 5/4 deck wood (not fastened)

Registration numbers - plastic board, HH-66 adhesive

Cover - over-size (18ft) to cover winch and motor

Side control - 5/4 wood stand lag-bolted to floor

Helm - remodeled BoatsToGo helm, attached to side control stand

Table - tray with up-down brackets, lag-bolted to floor

Bimini - c-clamped to splash rail, open/close from ground or in boat

Privacy curtains - clothes changing or portable-potty

LAUNCH & RETRIEVE BOAT

Launch - back trailer to slide boat off, then beach or dock boat

Retrieve - beach boat, trailer push boat to floating, winch onto roller bunk

Many supplies are available from Home Depot, Lowes, Menards, and Amazon.

EMT is Electrical Metal Pipe tubing (pipe cutter is useful)

PVC is Polyvinyl pipe used in plumbing (jig saw is useful)

5/4 is 5/4" boards for home decks (skill saw is useful)

2x2 and 2x4 lumber

Hex bolts, lag bolts, nuts, washers, rope, etc

TRAILER

The trailer is built around a Northern Tool 5x8ft trailer. In place of the coupler, a 12ft 3" square steel tube was added. Square u-bolt hangers support the tongue, allowing for flexible positioning; hex bolts lock the tongue in place at a desired length. A 3" coupler was mounted to the end of the tongue. A 20ft trailer extension cord is run through the tongue tube and attached to the trailer's original wiring. The roller bunk assembly was mounted to the trailer in five places, four on the trailer rails, one on the tongue. The 12v winch was mounted on a 5/4 board level with the boat bow harness connection. Eventually, the taillights were reattached to the roller bed.

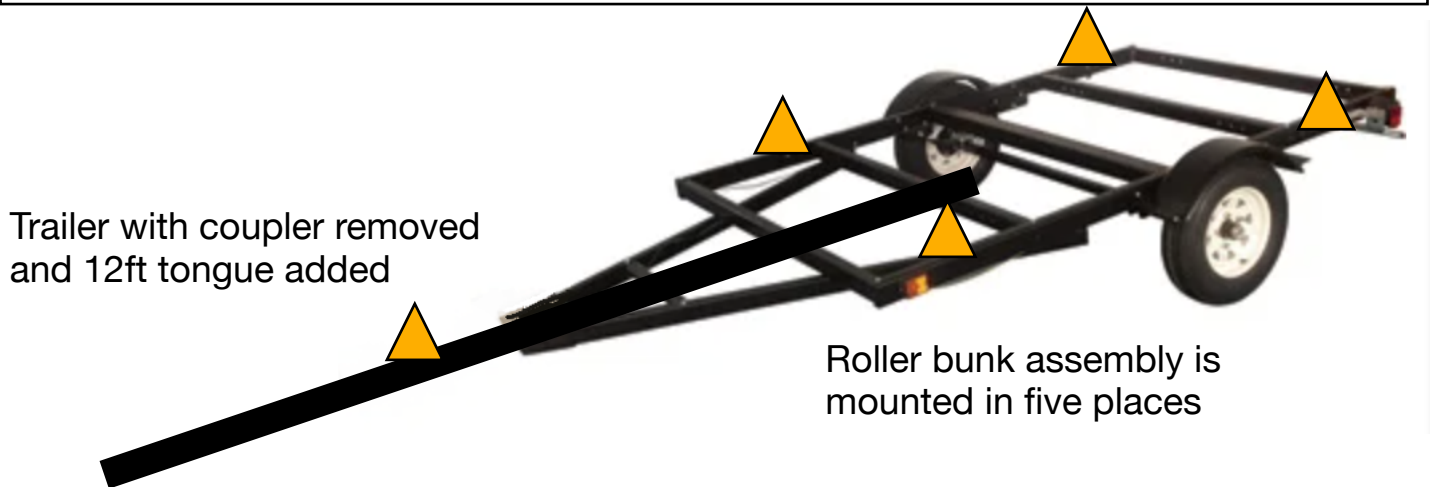

Note the white guides below

1. Forward stops.
2. Side guides.
3. Rear bumper guides - for pushing beached boat out to water for retrieving.



ROLLERS

The 14" rollers are 2" PVC pipe - 12" lengths with end caps (no adhesive needed). A 3/4" hole was drilled in end caps using a 3/4" wood spade bit for a centered, nicely rounded hole. The axles are 17" lengths of 3/4" EMT conduit. The axles are mounted with a hole in each end, or a 1/2" two-hole strap (yes, 1/2"). I tried both; either works.

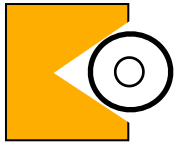
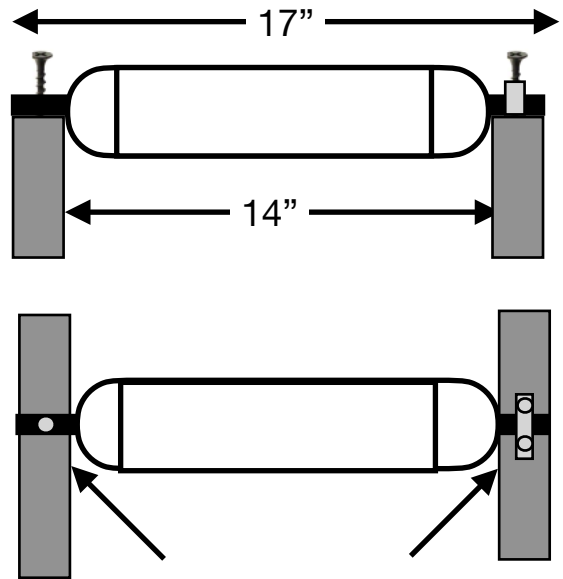

A simple piece of wood clamped on a drill press table can drill accurate holes in end caps.

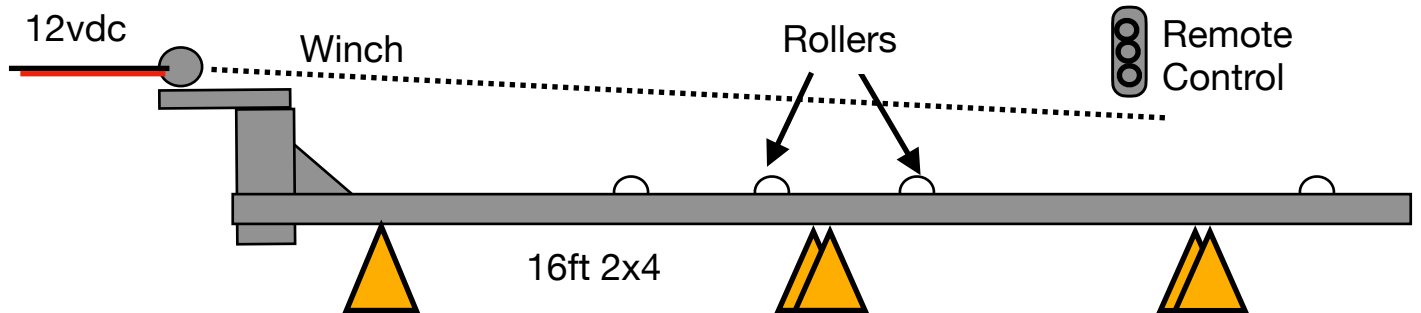

The four mounts on the trailer (and one on the tongue) are constructed of 5/4 deck board, sandwiching a 2x4 spacer, and bolt-clamped to the trailer rails.

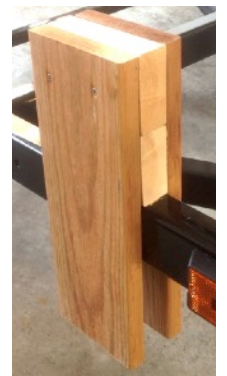

The guide posts are 24" EMT or 2x2 wood mounted to 2x4 wood blocks bolted to the 16ft roller bunks. A 30" PVC pipe with a cap is slipped onto the post. Guide posts can be located anywhere along the bunk rail

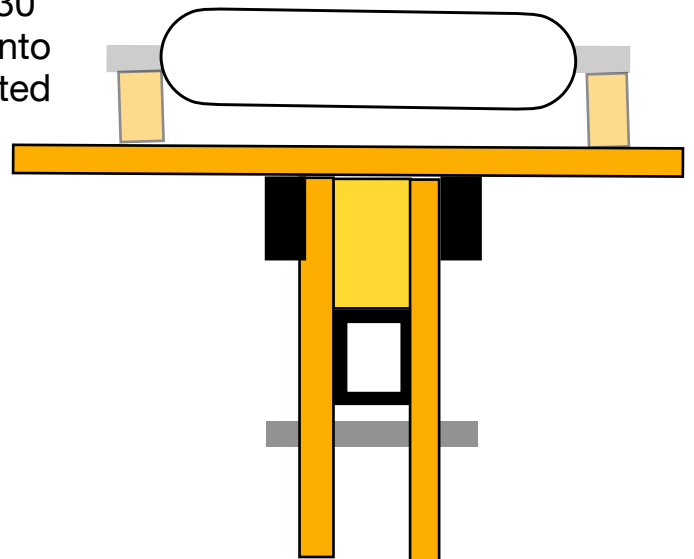
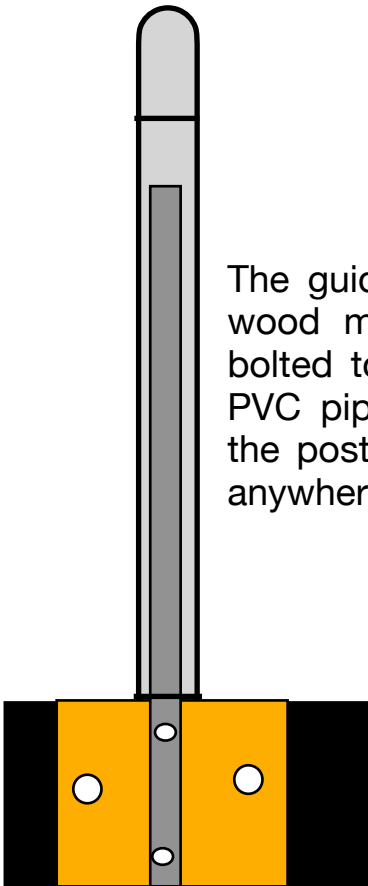

REMOTE CONTROLLED WINCH

The 12v remote controlled winch is mounted on a 5/4 wood platform inline with the boat bow. A “harness” is connected by chain to the two towing D-rings. Chain was stronger than rope and does not stretch, and it is easier to center the winch hook. Elastic cord at the bow keeps the harness in place while the boat is in the water.



Two-conductor SAE cords were used to connect the winch to the 12vdc car battery. Cords of various length can easily be connected and disconnected wherever desired. The winch remote control can operate the winch within about 30ft, including from inside the car.

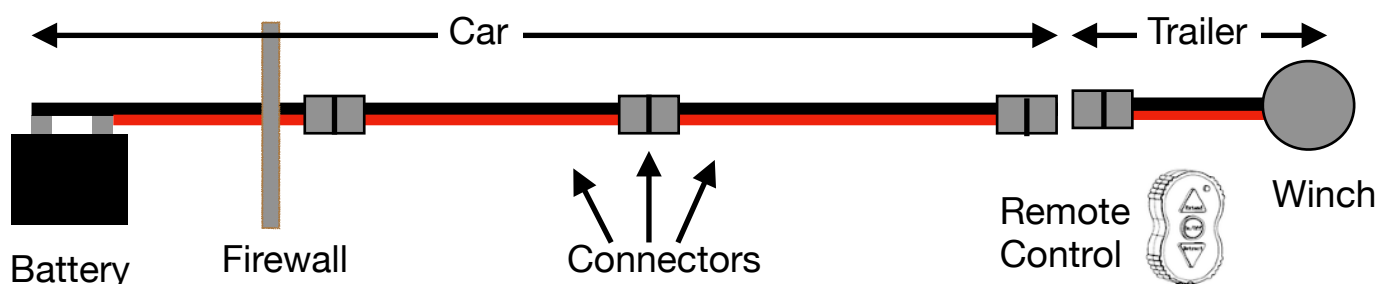

BOAT BILGE FLOOR

The bilge floor comprises a plywood sheet plus a styrofoam sheet under, on top of the boat's sectioned aluminum floor. Items such as seats are fastened to the plywood floor using appropriate size lag screws (with washers) long enough to penetrate the plywood floor but not long enough to hit the sectioned aluminum boat floor. A necessary tool is a ratchet socket wrench. A useful tool is a right-angle attachment for a power drill to drill lag screw pilot holes.

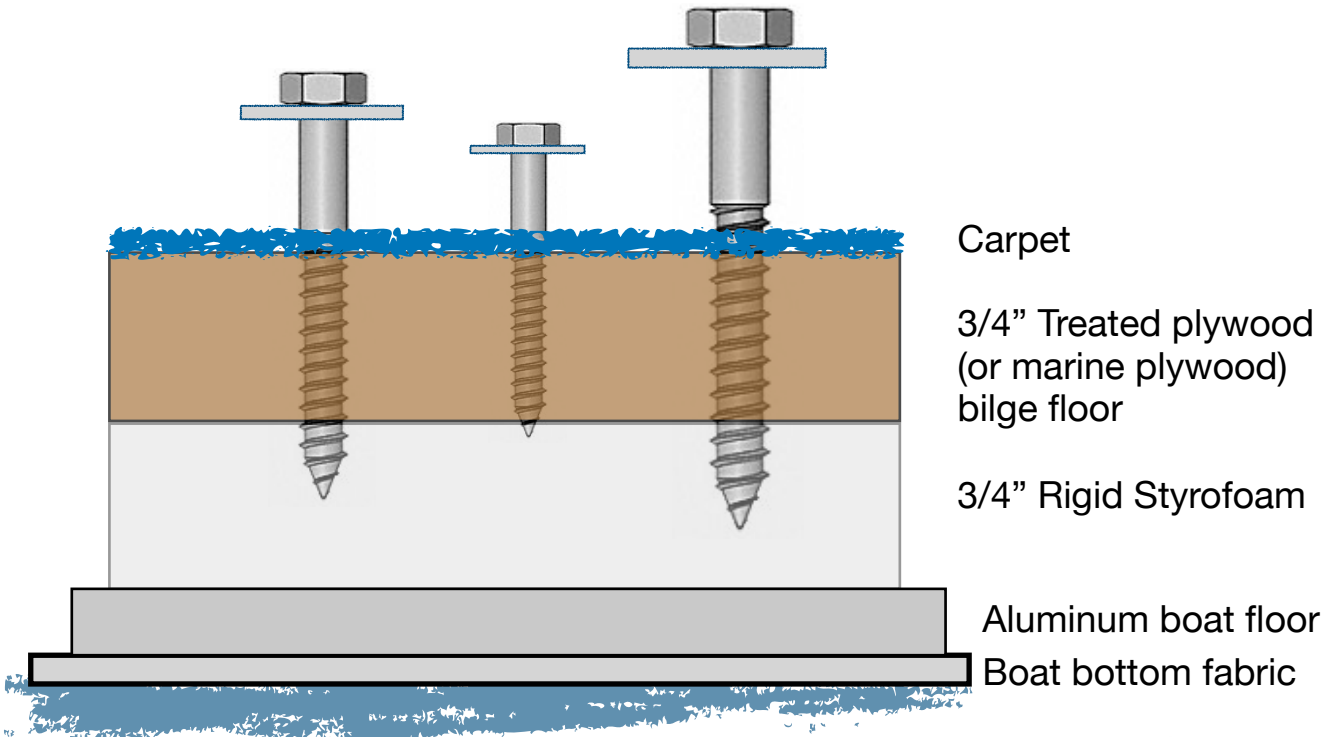

Pilot Hole Size for Softwood	Lag Screw Diameter	Pilot Hole Size for Hardwood
3/32"	1/4"	3/16"
9/64"	5/16"	7/32"
11/64"	3/8"	1/4"
1/4"	1/2"	11/32"
5/16"	5/8"	1/2"
3/8"	3/4"	9/16"

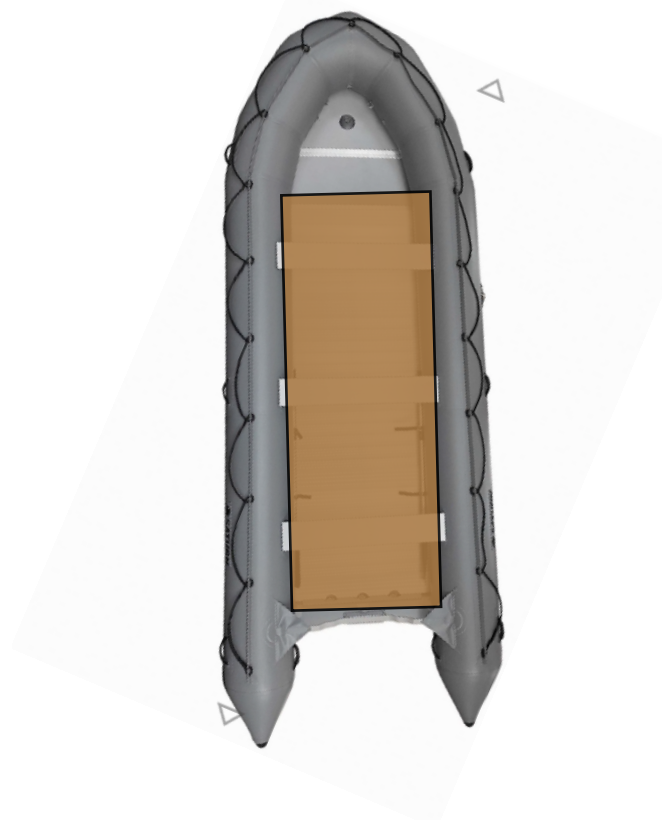

BOAT INTERIOR

The boat has a helm and four seats lag-screwed to the plywood bilge floor, plus a rear bench. The 8ft Bimini top folds down behind the motor. The motor is a Honda BF20D3SRT 20hp short-shaft outboard. 15ft and 16ft boats are rated for maximum 40hp. 20hp gets the boat on a plane with 1-4 passengers onboard; 30-40hp might be better for water skiing and other heavy duty use. The motor has a Doel-Fin hydrofoil as an aid in planing. 12ft control cables were chosen for shift and throttle. A Uflex ROTECH10 10ft Rotary Steering System and a steering wheel are mounted on the helm. The helm is a modified helm from BoatsToGo (no longer available). Space between adjacent seats allow moving about fore and aft. Three seats have a cup holder plus a smart-phone holder. Any seat back can be folded down for higher sitting. A removable bench at the transom covers the 3-gallon gas tank and the 12v battery. A convenient tray in front of the mate's seat can be folded up/down. Privacy curtains can be attached to the Bimini top for changing clothes or for a portable potty. Anything can be removed and/or relocated by unscrewing lag screws driven into the plywood bilge floor.



REGISTRATION NUMBERS

Registration numbers and license decals pose problems on inflatables. Numbers can be painted on with a stencil and appropriate spray paint. The stick-on license decals will not adhere well to the boat, however. Plastic plates with stick-on numbers and stick-on license decals can be hung on but must be secured to prevent flopping, especially when trailering the boat. I have used both systems; neither is fool-proof.

For the 16ft boat I used the plate method. The plastic plate is 1/4" corrugated plastic with stick-on numbers and stick-on license. I used HD-66 adhesive to conform and glue the plates to the boat. They adhere well, not flopping even trailering at 70mph. I attached thin nylon strings to the splash rail just in case a plate ever does come loose.



LAUNCH BOAT

One person can launch (and retrieve) the boat alone. (Having a second person handling the bow line and the winch remote can be very helpful, especially if a dock is nearby.)

1. Raise the motor. Secure a few inches of the bow line to the cleat near the winch, to keep the boat from rolling off. Winch-out a bit and disconnect the winch.
2. Back the trailer down the ramp. Un-cleat the bow line. Return to the car, holding the bow line in your hand out the car window, to keep the boat from rolling off the trailer too soon.
3. Back up, letting out line when the boat floats off the trailer. Drive up, holding the bow line, dragging the boat to **lightly** beach on the ramp. Lay bow line up the ramp in case the boat drifts off the ramp. Go park the boat and trailer.



RETRIEVE BOAT

Beach the boat. Lay the boat bow line on the ground for safety, in case the boat floats off. Back the trailer a foot or so from the bow of the beached boat, then...

Step 1 HOOK-UP

Attach the winch line to the boat. Back up and winch-in just enough to touch the bumpers. Return the boat bow line into the boat.

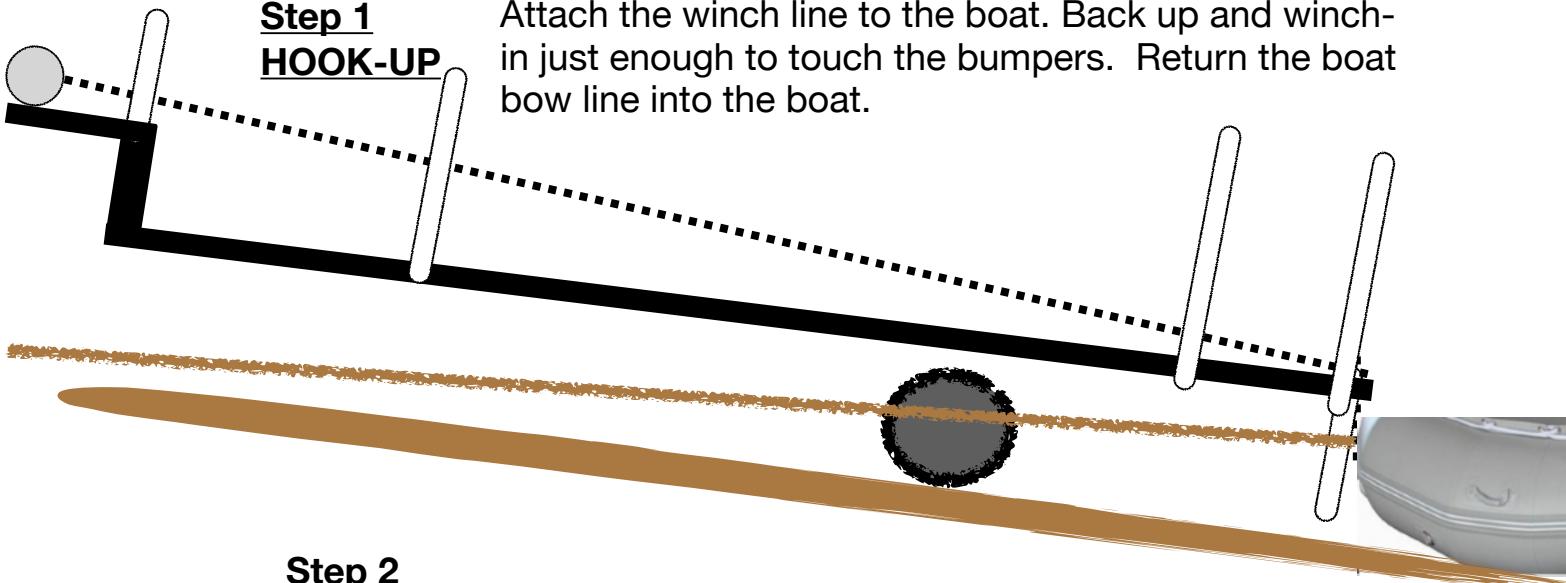

Step 2 ALIGN

Back the trailer, pushing the boat until the boat bow floats on the rollers. Gently winch-in to align the boat between the rear side guides.

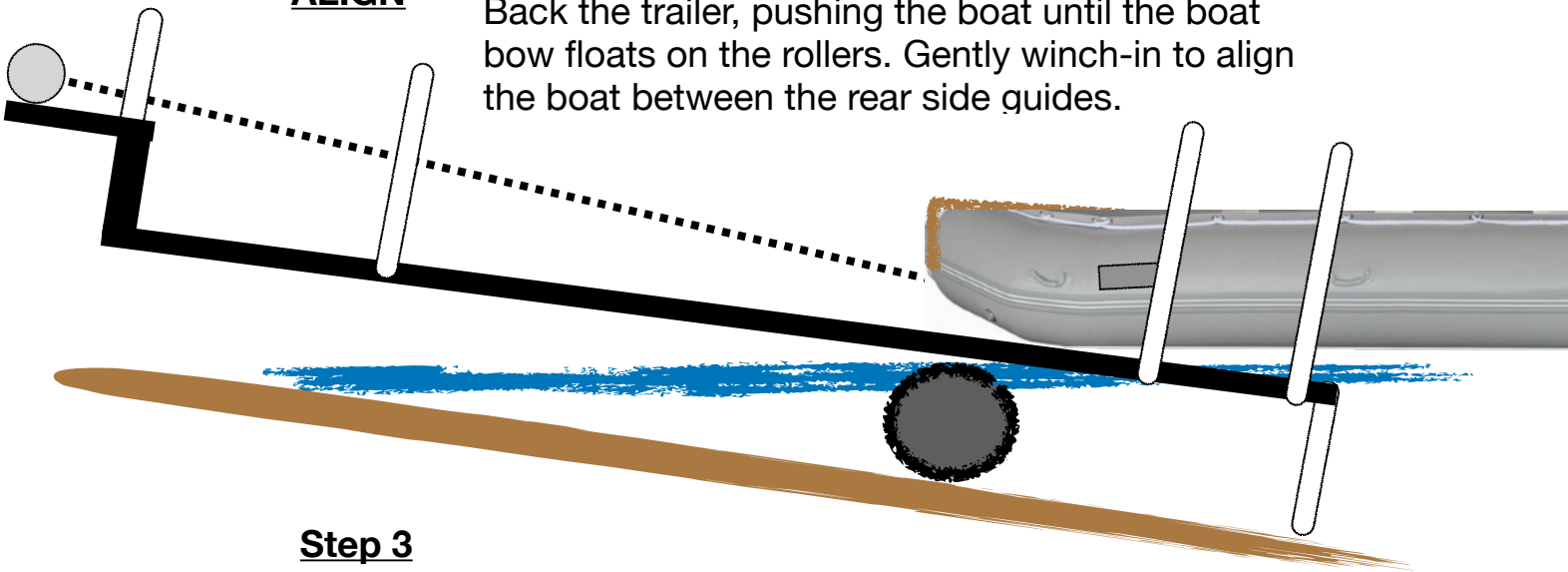

Step 3 WINCH-IN

Back up, winching-in until the boat's grab handle meets the front guide. Drive car, finish winch-in on land.

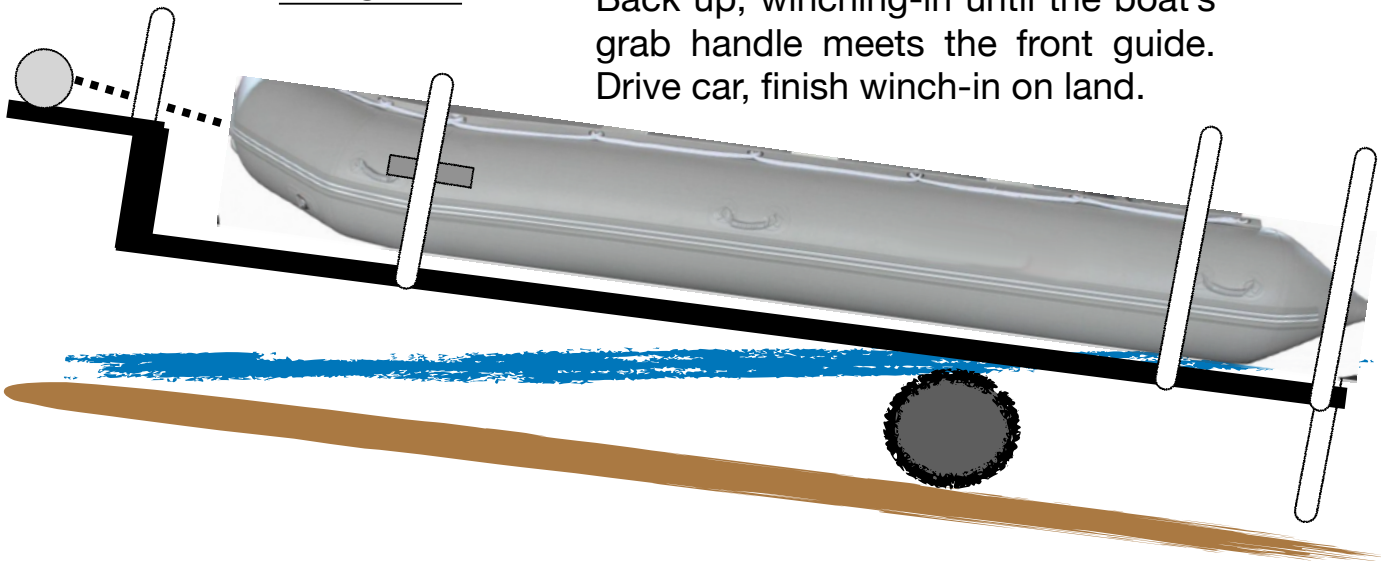

BOAT COVER

The cover is two feet longer than the boat (18ft cover on the 16ft boat) with elastic cord run through tarp clips on bow and on both sides of the tarp - but not the rear. Lower the Bimini top and cover it with the boat. Lower the motor all the way down.

1. Lay the cover on the winch and bow. Roll it open a few feet; secure the front.
2. Roll the cover all the way to the back; secure the back firmly.
3. Fasten the elastic cord around both sides.
4. Put retaining straps across the tarp.

Remove the cover in reverse. Unhook everything. Roll the cover from back to front



NOTES

Pressure treated 2x4's and outdoor 5/4 deck boards were used extensively on the trailer and in the boat. It was easy to cut pieces, drill holes, bolt or screw pieces, correct mistakes, and paint.

Exterior screws, lag bolts, hex bolts and nuts were used extensively.

The SAE 12v winch cables reverse polarity at each connector. Special polarity-reversing connectors can be interspersed at any junction.

Feeding the winch wiring through the car firewall was difficult. I got ideas from the internet for my specific car.

The boat side guides on the trailer should keep the boat as centered as possible. **Never winch-in all the way as the winch could jam or break.**

The helm was from BoatsToGo, and is no longer available.

Leave a 2" gap between the end of the plywood bilge floor and the transom to view any bilge water, and to service the bilge drains.

Pay special attention to securing the boat cover at the rear; that's where most "flapping" will occur.

Beach the boat gently on the ramp. After exiting the boat, lift the bow and pull it up the ramp a bit. Lay the bow line on shore as a safety measure - in case the boat drifts off the ramp.

If trailering the boat without a cover, be sure all loose items are removed or secure and will not blow off.

If the motor cavitates (sucks air) pump the tubes and keel up harder - as hard as possible if using a hand pump.

The three one-way bilge valves will drain most bilge water when the boat is under way, or while driving the trailered boat up hills.

In rough water, drive the boat about 45 degrees to big waves instead of head-on. Zig-zag as necessary - like a WWII ship avoiding torpedoes.

A boat hook is handy to retrieve that cap that blew off, or to pole the boat in very shallow water.

80 PSI is recommended for tires on the trailer (hard to read on a tire).

In all the inflatables I have owned, I never needed an anchor or running lights, but a flashlight was handy.

A battery-operated hand vacuum really does pick up sand from a boat floor.

On a hot day, a bottle of water is much better than a can of beer.

RESOURCES

Here is a list of many of the items purchased for the 16ft boat. Most items were purchased via Amazon, and some at Lowes and Home Depot stores.

HH-66 PVC Vinyl Cement Glue with Brush 8oz (1)
 Visit the RH Products Store
 ★★★★★ (1,985 ratings) | 74 answered questions
 -33% **\$19⁹⁹** (\$2.50 / Ounce)
 List Price: \$29.99
 May be available at a lower price from [other sellers](#), potentially without free Prime shipping.
Compatible Material Plastic

Arco Design Wood Fiber Set of 3 Units Serving Tray Breakfast Lunch Dinner Food Compliant (Set of 3 Units)
 Brand: Arco Design
 ★★★★★ (26 ratings)
\$19⁹⁹

Plaskolite 18 in. x 24 in. Corrugated Plastic Sheet
 ★★★★★ (44) | Questions & Answers (47)
\$7⁴⁸
 • Lightweight, trimmable design for versatile use
 • Great for yard signs or in arts and crafts projects
 • Resists weather and water damage for outdoor use
 • [View More Details](#)

iGreely SAE Extension Cable 10AWG SAE to SAE Quick Disconnect Wire Harness
 Visit the iGreely Store
 ★★★★★ (1,565 ratings)
\$16⁹⁹
 ✓ Prime & FREE Returns
 Coupon: Save an extra 5% when you apply this coupon. Terms
 Get 5% back (\$0.84 in rewards) on the amount charged to your Amazon Prime Rewards Visa Signature Card.
 Size: 6Ft

1Ft	3Ft	6Ft	10Ft	20Ft
\$8.99	\$11.98	\$16.99	\$22.99	\$45.99

Reese 80232 Hidden Hitch® Angle-Cut Class II Ball Mount - 16" x .75" x 2", 6000 lbs.
 Brand: Hidden Hitch
 ★★★★★ (551 ratings) | 17 answered questions
\$49⁰⁵
 Get 5% back (\$2.45 in rewards) on the amount charged to your Amazon Prime Rewards Visa Signature Card.
 Brand: Hidden Hitch
 Item: 8.5 Pounds

Davis Instruments Doel-Fin Outboard/Outdrive Stabilizer - Black (SS-SMS-5001211)
 Visit the Davis Instruments Store
 ★★★★★ (1,276 ratings) | 143 answered questions
 -15% **\$32²⁰**
 List Price: \$37.99
 ✓ Prime

Flotation Cushion, Blue, 16-Inch x 14-3/8-Inch
 Brand: STEARNS
 ★★★★★ (2,152 ratings) | 19 answered questions
 • Utility cushion doubles as a comfortable place to sit and as a flotation cushion
 • US Coast Guard-approved Type IV flotation device
 • Soft polyester shell and durable Crosstech flotation foam



Five Oceans Universal Outboard Motor Flusher, Marine Grade Rubber Muffs, PVC Coated High Tensile Steel Bracket, Rectangular, Round and Dual Flow Rectangular

Visit the [Five Oceans Store](#)
 ★★★★★ | 725 ratings
 | 29 answered questions

Amazon's Choice in Boat E...

\$14.90
 ✓prime & FREE R...
 FREE delivery Fri...
 Order within 8 hr...

Deliver to Royal - 78279

In Stock.

Qty: 1

Add to Cart

Buy Now

Secure transaction

Ships from Amazon

Sold by FIVE OCEANS

Details

Roll over image to zoom in



Seachoice Universal UV-Resistant 4-Spoke Marine Boat Steering Wheel

Visit the [SEACHOICE Store](#)
 ★★★★★ | 690 ratings
 | 37 answered questions

Amazon's Choice in Automotive Steering Wheels b...

Save 10% Lowest price in 30 days

List Price: ~~\$30.99~~ Details
 Price: **\$27.95** ✓prime & FREE Returns
 You Save: **\$3.04 (10%)**

Deliver to Royal - 78279

In Stock.

Qty: 1

Add to Cart

Buy Now

Secure transaction

Ships from Amazon

Sold by SEACHOICE

Details

Roll over image to zoom in



Uflex ROTECH10 Rotech Rotary Steering System, 10'

Brand: Uflex
 ★★★★★ | 202 ratings
 | 29 answered questions

-25% **\$170.99**
 List Price: ~~\$227.94~~

Get 5% back (\$8.54 in rewards) on the amount charged to your Amazon Prime Rewards Visa Signature Card.

Size: 10 Feet

8 Feet 9 Feet
 10 Feet 11 Feet

Add to Cart

Buy Now

Secure transaction

Ships from Huge Time

Sold by Huge Time

Return policy: Eligible for

Roll over image to zoom in



Reese Towpower 7014700 Tow 'N Store Lock Kit, Yellow

Visit the [Reese Store](#)
 ★★★★★ | 6,358 ratings
 | 49 answered questions

Amazon's Choice in Towing Hitch L...

List Price: ~~\$44.97~~ Details
 Price: **\$29.98** ✓prime & FREE Returns
 You Save: **\$14.99 (33%)**

Get 5% back (\$1.49 in rewards) on the amount charged to your Amazon Prime Rewards Visa Signature Card. May be available at a lower price from other sellers, potentially without free Prime shipping.

- Designed to provide excellent

Roll over image to zoom in



EPAuto Telescoping Lug Wrench, Wheel Wrench with CR-V Sockets (17/19, 21/22mm)

Visit the [EPAuto Store](#)
 ★★★★★ | 4,776 ratings

Amazon's Choice in Socket Wrench...

-20% **\$15.97**
 List Price: ~~\$19.99~~

✓prime & FREE Returns
 Get a \$60 Amazon Gift Card instantly

Roll over image to zoom in



10pcs Tarp Clips, Tarp Clamps, Tarp Clips Thumb, Tarp Clips Heavy Duty Lock Grip, Plastic Tent Clips Clamps, Poly Tarpaulin Clip, Reusable Linoleum Tent Clip, Canvas Clips for Outdoor Garden Farm

Brand: LQ-SCYCX-TT
 ★★★★★ | 307 ratings

Amazon's Choice in Tarps by LQ-SCYCX-TT

-58% **\$7.99**

Roll over image to zoom in



mankk 1.8ft SAE Power Socket Sidewall Port 10AWG Cable SAE Connector Weatherproof Universal Flush-Mountable Connector with Screws for Solar Generator Battery Charger M-V-013-LS

Visit the [mankk Store](#)
 ★★★★★ | 12 ratings

\$11.99

Roll over image to zoom in



STAR BRITE Extending Boat Hook - Telescoping, Floating, Multi-Purpose - Extends from 4 ft. (124 cm) to 8 ft. (243 cm) 040609

Visit the [STAR BRITE Store](#)
 ★★★★★ | 2,267 ratings
 | 20 answered questions

\$31.25
 ✓prime & FREE Returns
 Get 5% back (\$1.56 in rewards) on the amount charged to your Amazon Prime Rewards Visa Signature Card. May be available at a lower price from other sellers, potentially without free

Roll over image to zoom in



CARTMAN 1/4" Elastic Cord Crafting Stretch String, 40kg x 50ft, with 4 More Hooks, Blue Color

Visit the [CARTMAN Store](#)
 ★★★★★ | 3,049 ratings
 | 29 answered questions

-40% **\$11.99**
 List Price: ~~\$19.99~~

✓prime & FREE Returns
 Get 5% back (\$0.59 in rewards) on the amount charged to your Amazon Prime Rewards Visa Signature Card.

Roll over image to zoom in



CA 1234 SB
CA 1234 SB

2 pack

FONT B13

3" Pair of Boat Registration Number Decals | Custom Boat Hull ID Numbers & Letters | Custom Made for You | Choose Size, 17 Colors & 26 Fonts | Marine Vinyl

Brand: MxNumbers
★★★★☆ 1,381 ratings
42 answered questions

\$13.99



Airhead Adult General Purpose Life Vest 4-Pack, Multiple Colors Available

Visit the AIRHEAD Store
★★★★☆ 267 ratings
5 answered questions

Amazon's Choice in Life Jackets & ...

-7% \$115.50
Was: \$124.46

Get 5% back (\$5.77 in rewards) on the amount charged to your Amazon Prime Rewards Visa Signature Card. Not eligible for Amazon Prime. Available with free Prime shipping from other sellers on Amazon.

Color: Blue

\$115.50 **\$124.99**



Leader Accessories 10 Colors 4 Bow Bimini Top Boat Cover Include 4 Straps 2 Rear Support Poles Mounting Hardwares Storage Boot

Visit the Leader Accessories Store
★★★★☆ 1,380 ratings
191 answered questions

\$154.98

& FREE Returns

Coupon: Save an extra \$10



8 Pieces Wall Mount Phone Holder Adhesive Remote Control Storage Box Wall Mount Charging Phone Stand Holder Adhesive Non Slip Media Organizer Storage Box for Bedroom Kitchen Bathroom (Black)

Visit the Jetcac Store
★★★★☆ 310 ratings
3 answered questions

Save 10% Lowest price in 30 days

Price: \$14.99
Prime Price: **\$13.49** ✓prime
& FREE Returns
You Save: **\$1.50 (10%)**



Professional Folding Shelf Brackets, 2 Pcs Heavy Duty Stainless Steel Collapsible Bracket, Sturdy Brackets for DIY Space Saving Wall Mounted Work Bench (10inch)

Brand: Brands
★★★★☆ 16 ratings

\$11.99

& FREE Returns

Can be folded freely to save space for you



ROYHOO 4PCS Adjustable Folding Drink Holder Universal Car Cup Bottle Holder for Marine Boat Caravan Car Trucks RVs Vans with Wall Mounted Screws(Black)

Brand: ROYHOO
★★★★☆ 45 ratings

\$19.99

✓prime & FREE Returns

Get \$60 off instantly: Pay **\$0.00** \$19.99 upon approval for the Prime Store Card. No annual fee.



Attwood Economy Pedestal

Brand: attwood
★★★★☆ 845 ratings | 34 answered questions

Amazon's Choice for "boat seats and pedestals"

-9% \$22.29
List Price: \$24.46

✓prime & FREE Returns

Get 5% back (\$1.11 in rewards) on the amount charged to your Amazon Prime Rewards Visa Signature Card. May be available at a lower price from other sellers, potentially without free Prime shipping.

Size: 7-Inch



Sunway Solar SAE Polarity Reverse Adapter Connectors For SAE To SAE Quick Disconnect Extension Cable, Solar Panel Battery Power Charger And Maintainer-3Pack

Visit the Sunway Solar Store
★★★★☆ 704 ratings
7 answered questions

-36% \$6.99
List Price: \$10.99

✓prime & FREE Returns

Get 5% back (\$0.34 in rewards) on



Inflatable Boat Covers

★★★★★ 1 review

IMPORTANT: PLEASE SELECT CORRE

\$69.00

MSRP: \$138.00



Wise Standard Low Back Boat Seat
 Brand: Wise
 ★★★★★ 2,863 ratings
 | 62 answered questions

Color: Grey/Blue

Brand: Wise
 Color: Grey/Blue
 Material: Vinyl
 Vehicle Service Type: Fishing Boat
 Seat Width: 16 Inches

About this item



ABN Trailer Wire Extension, 20ft, 4-Way 4-Pin Plug Flat 20 Gauge – Hitch Light Trailer Wiring Harness Extender
 Visit the ABN Store
 ★★★★★ 1,790 ratings
 | 8 answered questions

\$14.99

Get 5% back (\$0.74 in rewards) on the amount charged to your Amazon Prime Rewards Visa Signature Card. Not eligible for Amazon Prime. Available with free Prime shipping from other sellers on Amazon.

Size: 20 ft.

1 ft. \$9.99	4 ft. \$10.99	8 ft. \$12.99 prime	10 ft. \$13.99
-----------------	------------------	---------------------------	-------------------

20 ft.
\$14.99

Roll over image to zoom in



BADLAND ZXR >
 2500 lb. ATV/Utility Winch with Wire Rope and Wireless Remote Control

★★★★★ (611) Write a Review

Recover your ATV safely and quickly with this electric ATV winch

\$89.99



Reg. \$549.99
Sale \$499.99
 Save \$50.00

PayPal Pay in 4 in

1 **+ Add**

Ship It



16' Inflatable Boats SD488
 ★★★★★ 7 reviews

\$1,799.00
 MSRP: \$3,598.00

COLOR:
 Dark Gray



Analog High-Pressure Electric Pump
 ★★★★★ 2 reviews

\$89.00
 MSRP: \$178.00

MODEL: GP805
 Shipping: \$19.00
 Availability: In stock
 Quantity: 1

ADD TO CART